

INDUSTRIAL . AUTOMOTIVE . AUTOMATION . ENERGY

SMART AUTOMOTIVE SOLUTIONS



INTELLIGENT SOLUTIONS

FOR MORE EFFICIENCY AND SAFETY

INTELLIGENTE LÖSUNGEN

FÜR MEHR EFFIZIENZ UND SICHERHEIT

BETTER HANDLING

BESSERE HANDHABUNG

IP PROTECTION CLASS UP TO IP 69K

IP SCHUTZKLASSE BIS ZU IP 69K

COMPACT DESIGN

KURZE BAUFORM

LED OR SURGE SUPPRESSION OPTIONAL

LED-DIODE/VARISTOR

HIGH EXTRACTION FORCE

OPTIMALE ZUGENTLASTUNG

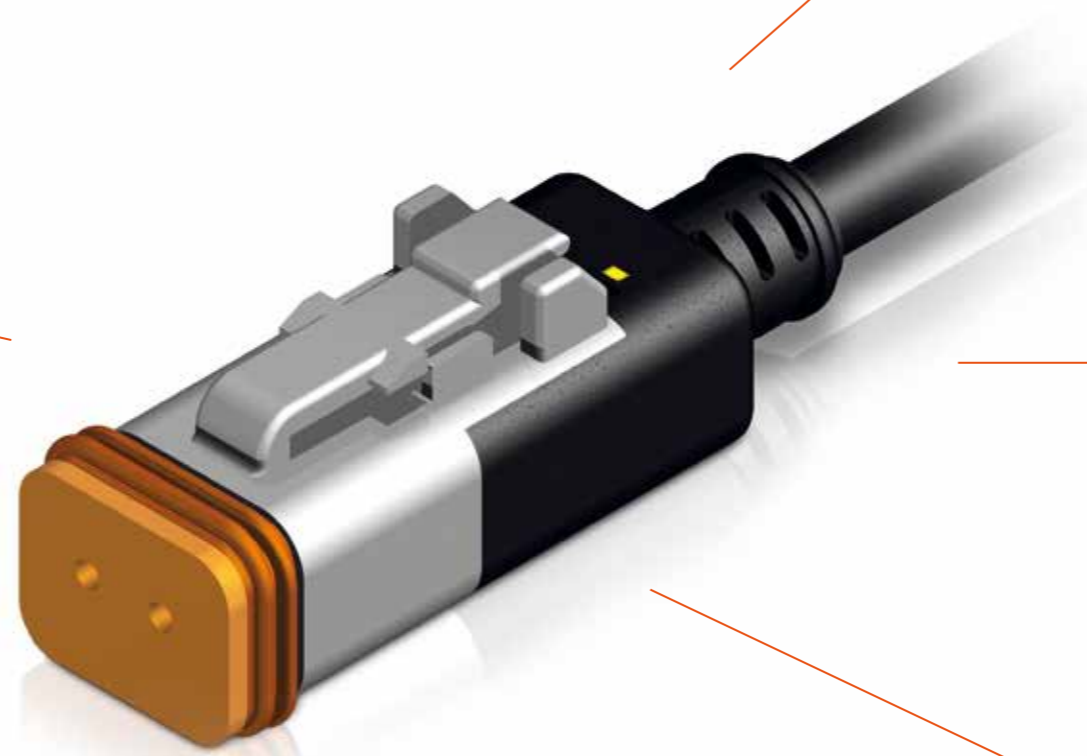

QUALITY AND INNOVATIONS

FROM GERMANY

QUALITÄT UND INNOVATIONEN

AUS DEUTSCHLAND

FOUNDED IN 1974, PETERS INDU-PRODUKT HAS DEVELOPED INTO A COMPANY THAT OPERATES ON AN INTERNATIONAL BASE. PERFECTION IS OUR CONSTANT AIM AND TECHNICAL KNOWLEDGE IS THE TOOL WE USE TO ACHIEVE IT. WITH THIS STRATEGY, WE HAVE DEVELOPED A STANDARD OF QUALITY THAT HAS CONTINUALLY CONVINCED CUSTOMERS WORLDWIDE. WE ARE CONSTANTLY EXPANDING OUR PRODUCT PORTFOLIOS IN THE INDUSTRIAL, AUTOMOTIVE, AUTOMATION AND ENERGY FIELDS. MOREOVER, WE DEVELOP TAILOR-MADE SOLUTIONS THAT SUIT THE NEEDS OF OUR CUSTOMERS – RIGHT FROM THE INITIAL IDEA TO THE FINISHED PRODUCT.

SEIT DEM GRÜNDUNGSJAHR 1974 HAT SICH PETERS INDU-PRODUKT ZU EINEM UNTERNEHMEN MIT INTERNATIONALEM WIRKUNGSKREIS ENTWICKELT. PERFEKTION IST UNSER ANSPRUCH UND TECHNISCHES KNOW-HOW IST UNSER WERKZEUG. AUF DIESE WEISE HABEN WIR EIN QUALITÄTSNIVEAU ENTWICKELT, DAS KUNDEN WELTWEIT ÜBERZEUGT. UNSERE PRODUKTPORTFOLIOS IN DEN BEREICHEN INDUSTRIAL, AUTOMOTIVE, AUTOMATION UND ENERGY ERWEITERN WIR LAUFEND. DARÜBER HINAUS ENTWICKELN WIR VON DER ERSTEN IDEE BIS ZUM FERTIGEN PRODUKT INDIVIDUELLE LÖSUNGEN IM KUNDENAUFTRAG.



Our "Automotive" business field comprises a wide range of molded connectors such as Deutsch DT-series, Tyco Super Seal, Tyco Junior Power Timer and the Delphi Metri-Pack. They are commonly used in mobile applications, agricultural equipment and the hydraulic industry. We offer standard connectors as well as customer specific connectors, made in our factory. To individualize and customize our products we develop solutions in our in-house tool shop. Our molded connector lines ensure a better handling, short construction form and a higher extraction force with an ambient temperature between -20°C and $+80^{\circ}\text{C}$.

A surge suppression or a LED-version of the connectors is available as an option.

Please feel free to contact us if you have any questions.

Unser Geschäftsbereich „Automotive“ umfasst eine Vielzahl von angespritzten Steckverbindern wie die Deutsch DT-Serie, Tyco Super Seal, Tyco Junior Power Timer und den Delphi Metri-Pack. Verwendung finden unsere Steckverbindungen in mobilen Anwendungen, Baumaschinen, Landmaschinen und in der hydraulischen Industrie. Neben den Standard-Steckverbindern bieten wir kundenspezifische Applikationen und Verbindungen. Unsere Steckverbinder gewährleisten eine bessere Handhabung, eine kurze Bauform und eine optimale Zugentlastung bei einer Umgebungstemperatur von -20°C bis $+80^{\circ}\text{C}$. Eine Schutzbeschaltung mit integrierter LED-Anzeige sowie diverse Kabeltypen sind optional verfügbar.

Sprechen Sie uns an, wenn Sie Fragen haben. Wir stehen Ihnen gerne als Ansprechpartner zur Verfügung.



TYCO SUPERSEAL

2-POLE/2-POLIG

Tyco Superseal
2-pole/2-polig



1 – Male/Stecker
2 – Female/Buchse

DETAILS

- _ Rated voltage **0 to 24 VDC**
- _ Operating current **11 A**
- _ Cable **2 x 1,0 mm²**
- _ Connector **AMP SUPERSEAL 1,5 Series 2-pol.**
- _ Protection class up to **IP 69K**
- _ Housing material **PA**
- _ Locking system **snap-lock**
- _ Temperature range **-20 °C to +80 °C**
- _ LED/surge suppression available on request

- _ Betriebsspannung **0 bis 24 VDC**
- _ Dauerstrom **11 A**
- _ Leitung **2 x 1,0 mm²**
- _ Steckverbinder **AMP SUPERSEAL 1,5 Series 2-pol.**
- _ Schutzart bis zu **IP 69K**
- _ Gehäusematerial **PA**
- _ Befestigung **Schnappverriegelung**
- _ Temperaturbereich **-20 °C bis +80 °C**
- _ LED/Schutzbeschaltung auf Anfrage

TYCO SUPERSEAL

3-POLE/3-POLIG

Tyco Superseal
3-pole/3-polig



1 – Male/Stecker
2 – Female/Buchse

DETAILS

- _ Rated voltage **0 to 24 VDC**
- _ Operating current **11 A**
- _ Cable **3 x 1,0 mm²**
- _ Connector **AMP SUPERSEAL 1,5 Series 3-pol.**
- _ Protection class up to **IP 69K**
- _ Housing material **PA**
- _ Locking system **snap-lock**
- _ Temperature range **-20 °C to +80 °C**
- _ LED/surge suppression available on request

- _ Betriebsspannung **0 bis 24 VDC**
- _ Dauerstrom **11 A**
- _ Leitung **3 x 1,0 mm²**
- _ Steckverbinder **AMP SUPERSEAL 1,5 Series 3-pol.**
- _ Schutzart bis zu **IP 69K**
- _ Gehäusematerial **PA**
- _ Befestigung **Schnappverriegelung**
- _ Temperaturbereich **-20 °C bis +80 °C**
- _ LED/Schutzbeschaltung auf Anfrage

TYCO SUPERSEAL 4-POLE/4-POLIG

Tyco Superseal
4-pole/4-polig

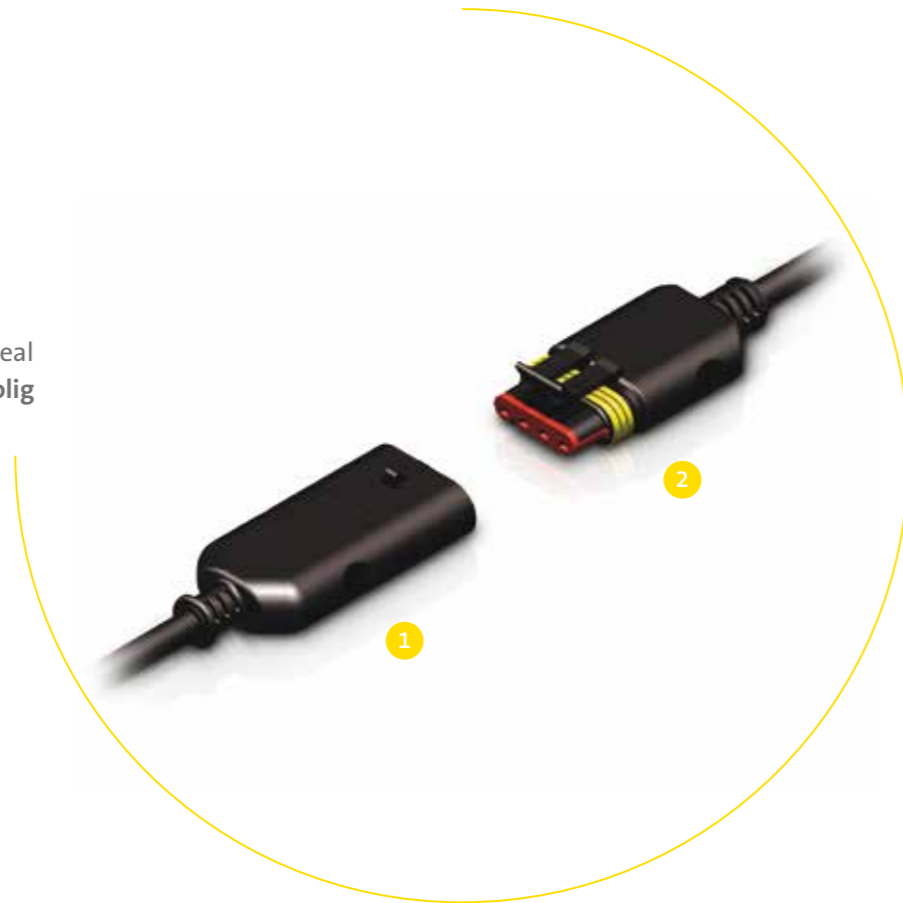

1 – Male/Stecker
2 – Female/Buchse

DETAILS

_ Rated voltage **0 to 24 VDC**

_ Operating current **11 A**

_ Cable **4 x 1,0 mm²**

_ Connector **AMP SUPERSEAL 1,5 Series 4-pol.**

_ Protection class up to **IP 69K**

_ Housing material **PA**

_ Locking system **snap-lock**

_ Temperature range **-20 °C to +80 °C**

_ LED/surge suppression available on request

_ Betriebsspannung **0 bis 24 VDC**

_ Dauerstrom **11 A**

_ Leitung **4 x 1,0 mm²**

_ Steckverbinder **AMP SUPERSEAL 1,5 Series 4-pol.**

_ Schutzart bis zu **IP 69K**

_ Gehäusematerial **PA**

_ Befestigung **Schnappverriegelung**

_ Temperaturbereich **-20 °C bis +80 °C**

_ LED/Schutzbeschaltung auf Anfrage

TYCO SUPERSEAL 5-POLE/5-POLIG

Tyco Superseal
5-pole/5-polig



1 – Male/Stecker
2 – Female/Buchse

DETAILS

_ Rated voltage **0 to 24 VDC**

_ Operating current **11 A**

_ Cable **5 x 1,0 mm²**

_ Connector **AMP SUPERSEAL 1,5 Series 5-pol.**

_ Protection class up to **IP 69K**

_ Housing material **PA**

_ Locking system **snap-lock**

_ Temperature range **-20 °C to +80 °C**

_ LED/surge suppression available on request

_ Betriebsspannung **0 bis 24 VDC**

_ Dauerstrom **11 A**

_ Leitung **5 x 1,0 mm²**

_ Steckverbinder **AMP SUPERSEAL 1,5 Series 5-pol.**

_ Schutzart bis zu **IP 69K**

_ Gehäusematerial **PA**

_ Befestigung **Schnappverriegelung**

_ Temperaturbereich **-20 °C bis +80 °C**

_ LED/Schutzbeschaltung auf Anfrage

TYCO SUPERSEAL

6-POLE/6-POLIG

Tyco Superseal
6-pole/6-polig

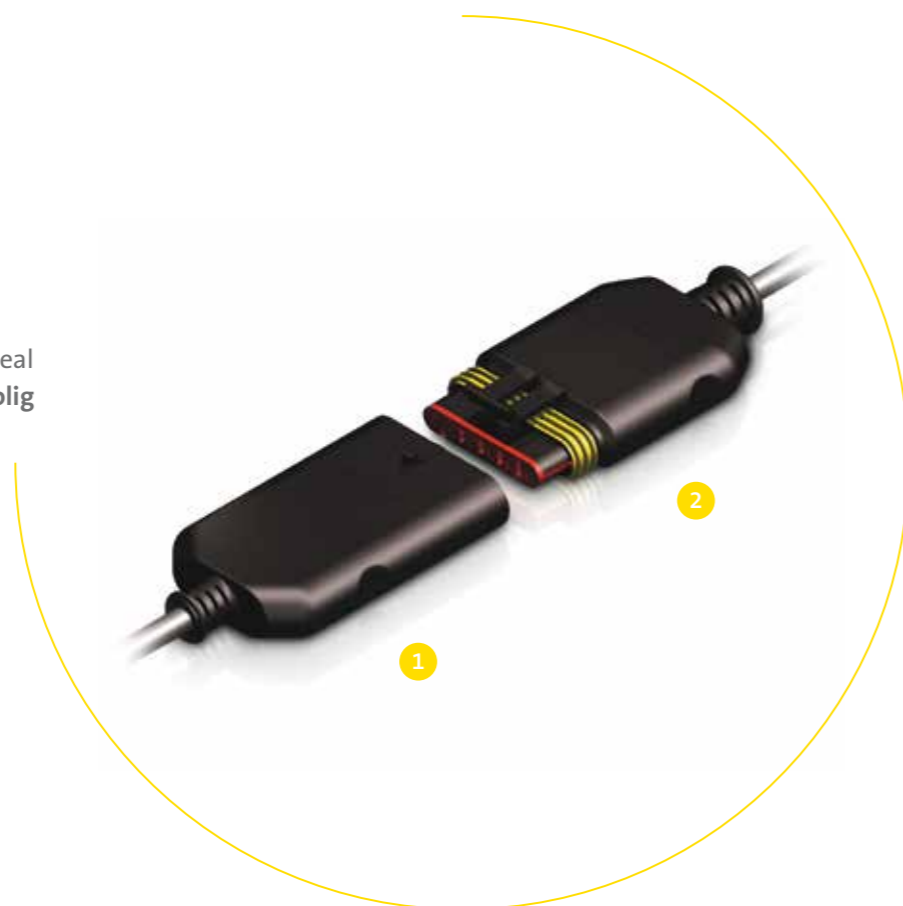

1 – Male/Stecker
2 – Female/Buchse

DETAILS

_ Rated voltage 0 to 24 VDC	_ Betriebsspannung 0 bis 24 VDC
_ Operating current 11 A	_ Dauerstrom 11 A
_ Cable 6 x 1,0 mm²	_ Leitung 6 x 1,0 mm²
_ Connector AMP SUPERSEAL 1,5 Series 6-pol.	_ Steckverbinder AMP SUPERSEAL 1,5 Series 6-pol.
_ Protection class up to IP 69K	_ Schutzart bis zu IP 69K
_ Housing material PA	_ Gehäusematerial PA
_ Locking system snap-lock	_ Befestigung Schnappverriegelung
_ Temperature range -20 °C to +80 °C	_ Temperaturbereich -20 °C bis +80 °C
_ LED/surge suppression available on request	_ LED/Schutzbeschaltung auf Anfrage

ORDER CODE/BESTELNUMMERN

TYCO SUPERSEAL

2-POLE/2-POLIG

Type/Ausführung	2 m	5 m	10 m
	Part No./Artikel Nr.	Part No./Artikel Nr.	Part No./Artikel Nr.
1 – Male/Stecker	932068	932069	932070
2 – Female/Buchse	932071	932072	932073

3-POLE/3-POLIG

Type/Ausführung	2 m	5 m	10 m
	Part No./Artikel Nr.	Part No./Artikel Nr.	Part No./Artikel Nr.
1 – Male/Stecker	932074	932075	932076
2 – Female/Buchse	932077	932078	932079

4-POLE/4-POLIG

Type/Ausführung	2 m	5 m	10 m
	Part No./Artikel Nr.	Part No./Artikel Nr.	Part No./Artikel Nr.
1 – Male/Stecker	932080	932081	932082
2 – Female/Buchse	932083	932084	932085

5-POLE/5-POLIG

Type/Ausführung	2 m	5 m	10 m
	Part No./Artikel Nr.	Part No./Artikel Nr.	Part No./Artikel Nr.
1 – Male/Stecker	932086	932087	932088
2 – Female/Buchse	932089	932090	932091

6-POLE/6-POLIG

Type/Ausführung	2 m	5 m	10 m
	Part No./Artikel Nr.	Part No./Artikel Nr.	Part No./Artikel Nr.
1 – Male/Stecker	932092	932093	932094
2 – Female/Buchse	932095	932096	932097

DEUTSCH DT 2-POLE/2-POLIG

Deutsch DT
2-pole/2-polig

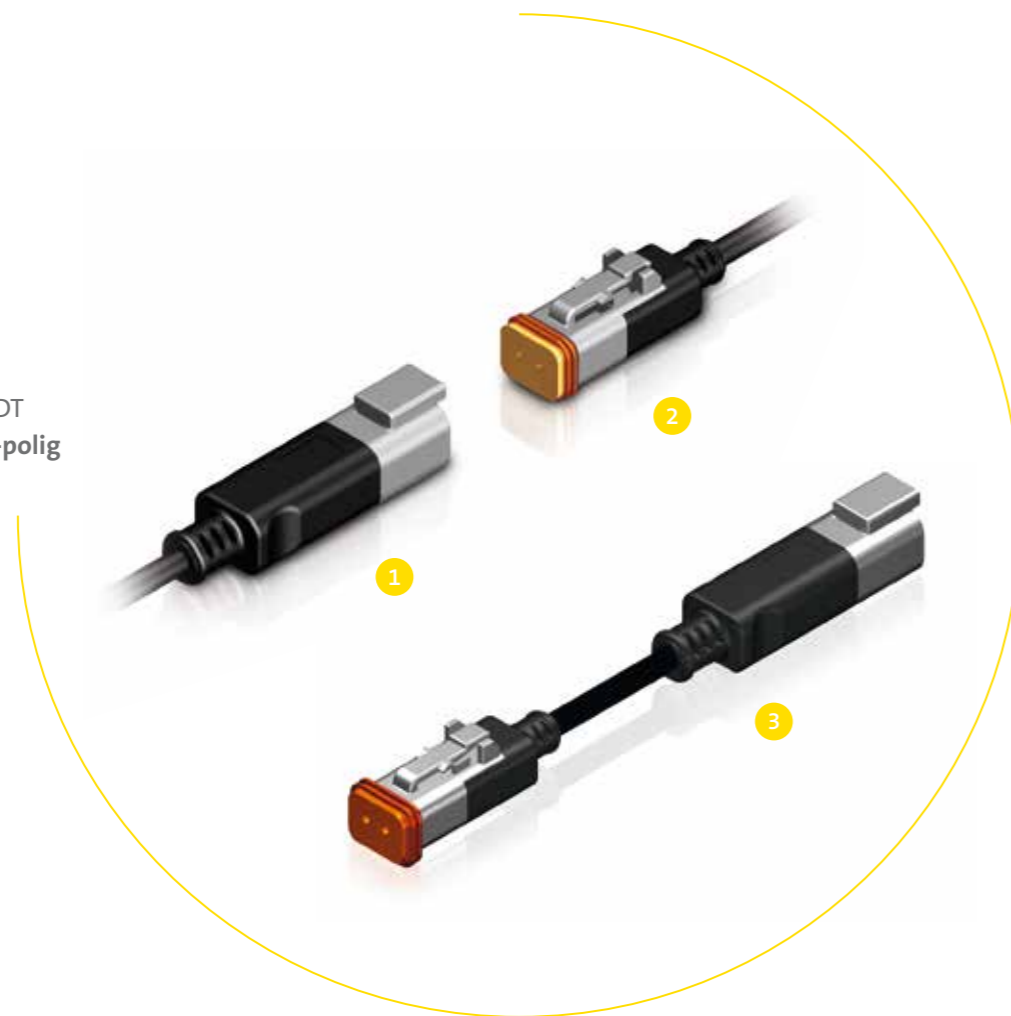

- 1 – Male/Stecker
- 2 – Female/Buchse
- 3 – Connecting cable/Verbindungsleitung

DETAILS

- _ Rated voltage **10 V to 30 V**
- _ Operating current **13 A**
- _ Cable **2 x 0,75 mm²**
- _ Connector **Deutsch DT Serie**
- _ Protection class up to **IP 69K**
- _ Housing material **PA**
- _ Locking system **snap-lock**
- _ Temperature range **-20 °C to +80 °C**
- _ LED/surge suppression available on request

- _ Betriebsspannung **10 V bis 30 V**
- _ Dauerstrom **13 A**
- _ Leitung **2 x 0,75 mm²**
- _ Steckverbinder **Deutsch DT Serie**
- _ Schutzart bis zu **IP 69K**
- _ Gehäusematerial **PA**
- _ Befestigung **Schnappverriegelung**
- _ Temperaturbereich **-20 °C bis +80 °C**
- _ LED/Schutzbeschaltung auf Anfrage

DEUTSCH DT 3-POLE/3-POLIG

Deutsch DT
3-pole/3-polig

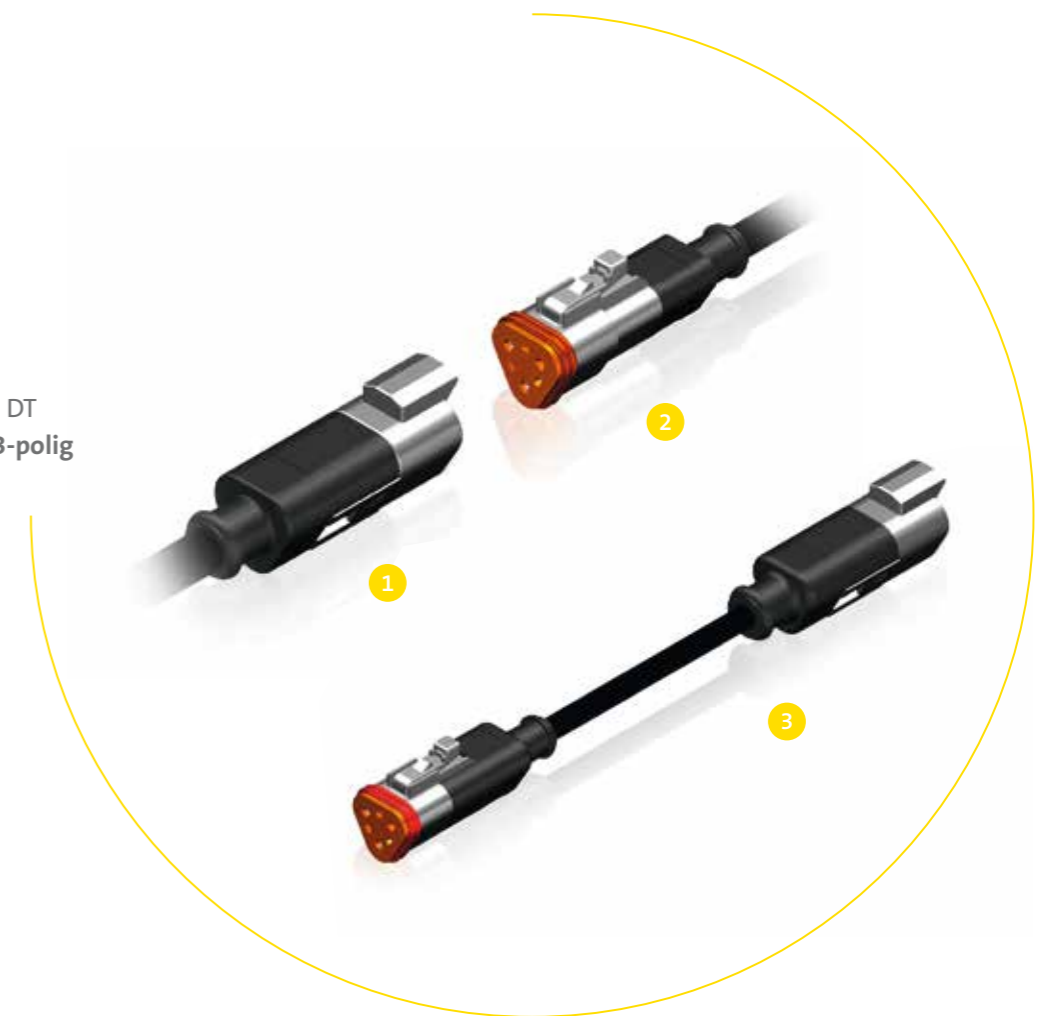

- 1 – Male/Stecker
- 2 – Female/Buchse
- 3 – Connecting cable/Verbindungsleitung

DETAILS

- _ Rated voltage **0 to 230 V**
- _ Operating current **13 A**
- _ Cable **3 x 1,0 mm²**
- _ Connector **Deutsch DT Serie**
- _ Protection class up to **IP 69K**
- _ Housing material **PA**
- _ Locking system **snap-lock**
- _ Temperature range **-20 °C to +80 °C**
- _ LED/surge suppression available on request

- _ Betriebsspannung **0 bis 230 V**
- _ Dauerstrom **13 A**
- _ Leitung **3 x 1,0 mm²**
- _ Steckverbinder **Deutsch DT Serie**
- _ Schutzart bis zu **IP 69K**
- _ Gehäusematerial **PA**
- _ Befestigung **Schnappverriegelung**
- _ Temperaturbereich **-20 °C bis +80 °C**
- _ LED/Schutzbeschaltung auf Anfrage

DEUTSCH DT

4-POLE/4-POLIG

Deutsch DT
4-pole/4-polig

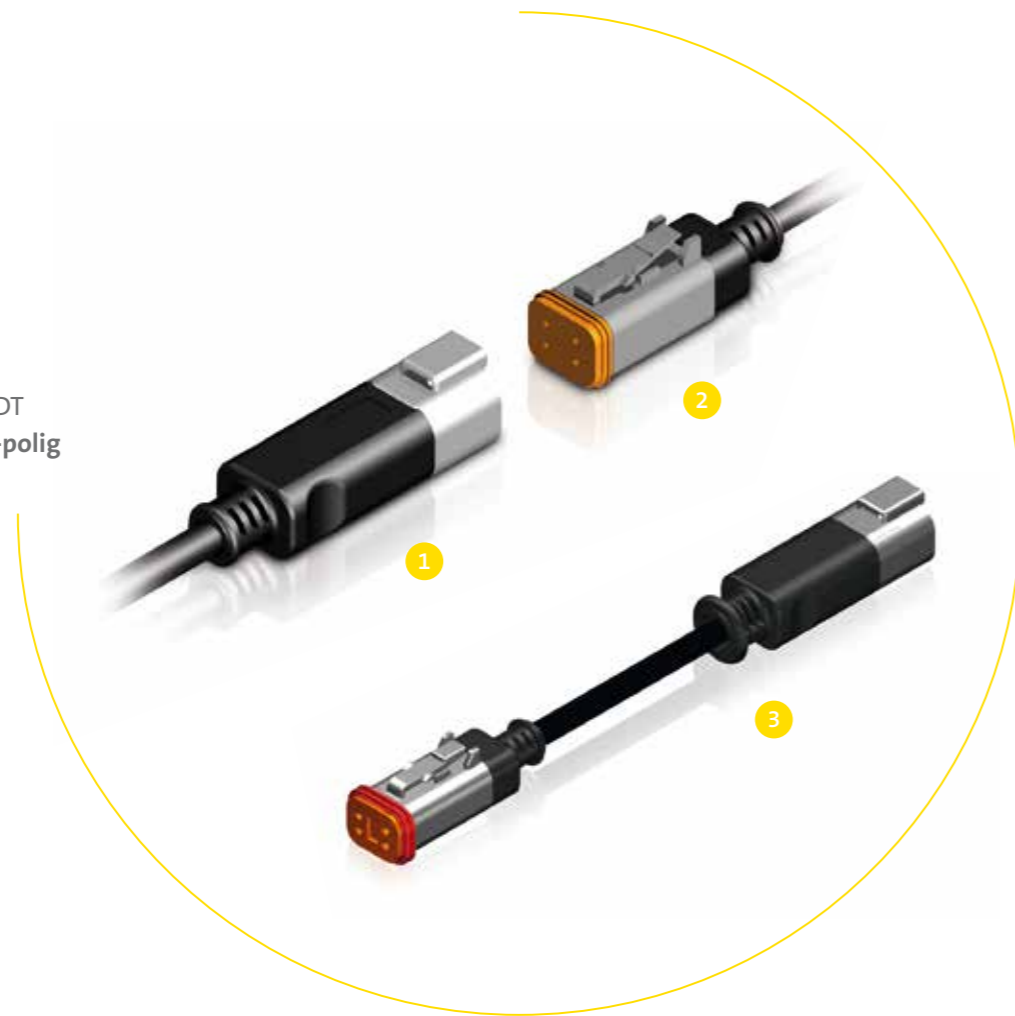

- 1 – Male/Stecker
- 2 – Female/Buchse
- 3 – Connecting cable/Verbindungsleitung

DETAILS

- _ Rated voltage **0 to 230 V**
- _ Operating current **13 A**
- _ Cable **4 x 1,0 mm²**
- _ Connector **Deutsch DT Serie**
- _ Protection class up to **IP 69K**
- _ Housing material **PA**
- _ Locking system **snap-lock**
- _ Temperature range **-20 °C to +80 °C**
- _ LED/surge suppression available on request

- _ Betriebsspannung **0 bis 230 V**
- _ Dauerstrom **13 A**
- _ Leitung **4 x 1,0 mm²**
- _ Steckverbinder **Deutsch DT Serie**
- _ Schutzart bis zu **IP 69K**
- _ Gehäusematerial **PA**
- _ Befestigung **Schnappverriegelung**
- _ Temperaturbereich **-20 °C bis +80 °C**
- _ LED/Schutzbeschaltung auf Anfrage

DEUTSCH DT

6-POLE/6-POLIG

Deutsch DT
6-pole/6-polig

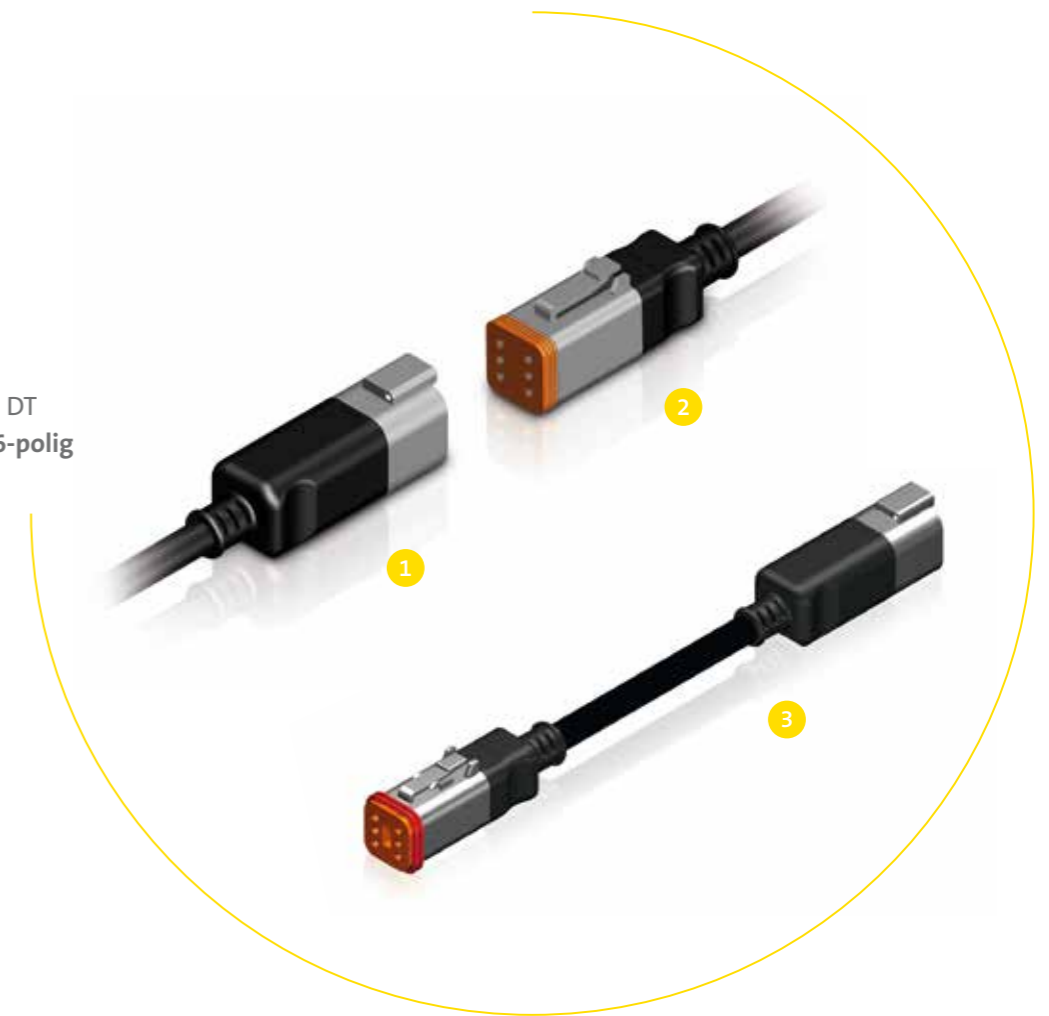

- 1 – Male/Stecker
- 2 – Female/Buchse
- 3 – Connecting cable/Verbindungsleitung

DETAILS

- _ Rated voltage **0 to 230 V**
- _ Operating current **13 A**
- _ Cable **6 x 1,0 mm²**
- _ Connector **Deutsch DT Serie**
- _ Protection class up to **IP 69K**
- _ Housing material **PA**
- _ Locking system **snap-lock**
- _ Temperature range **-20 °C to +80 °C**
- _ LED/surge suppression available on request

- _ Betriebsspannung **0 bis 230 V**
- _ Dauerstrom **13 A**
- _ Leitung **6 x 1,0 mm²**
- _ Steckverbinder **Deutsch DT Serie**
- _ Schutzart bis zu **IP 69K**
- _ Gehäusematerial **PA**
- _ Befestigung **Schnappverriegelung**
- _ Temperaturbereich **-20 °C bis +80 °C**
- _ LED/Schutzbeschaltung auf Anfrage

DEUTSCH DT

8-POLE/8-POLIG

Deutsch DT
8-pole/8-polig

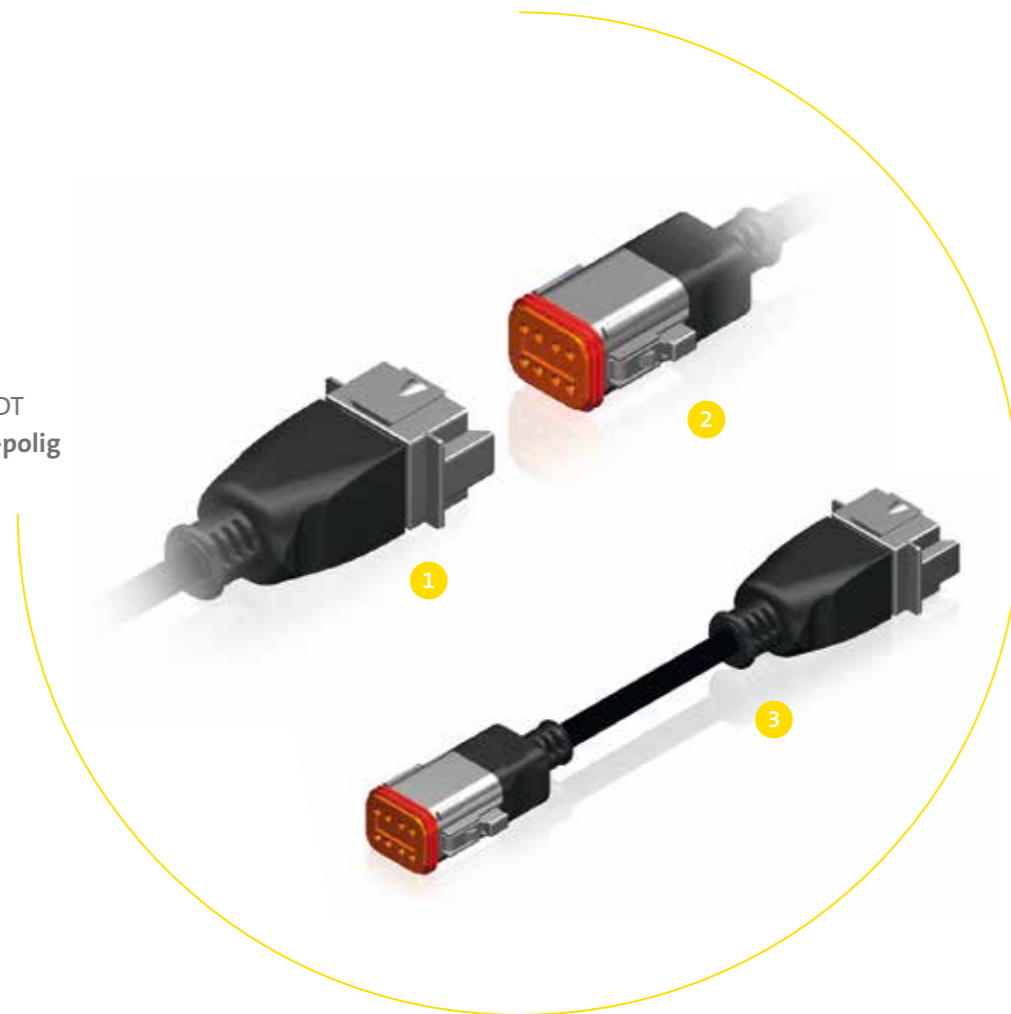

- 1 – Male/Stecker
- 2 – Female/Buchse
- 3 – Connecting cable/Verbindungsleitung

DETAILS

- _ Rated voltage **0 to 230 V**
- _ Operating current **13 A**
- _ Cable **8 x 1,0 mm²**
- _ Connector **Deutsch DT Serie**
- _ Protection class up to **IP 69K**
- _ Housing material **PA**
- _ Locking system **snap-lock**
- _ Temperature range **-20 °C to +80 °C**
- _ LED/surge suppression available on request

- _ Betriebsspannung **0 bis 230 V**
- _ Dauerstrom **13 A**
- _ Leitung **8 x 1,0 mm²**
- _ Steckverbinder **Deutsch DT Serie**
- _ Schutzart bis zu **IP 69K**
- _ Gehäusematerial **PA**
- _ Befestigung **Schnappverriegelung**
- _ Temperaturbereich **-20 °C bis +80 °C**
- _ LED/Schutzbeschaltung auf Anfrage

DEUTSCH DT

12-POLE/12-POLIG

Deutsch DT
12-pole/12-polig

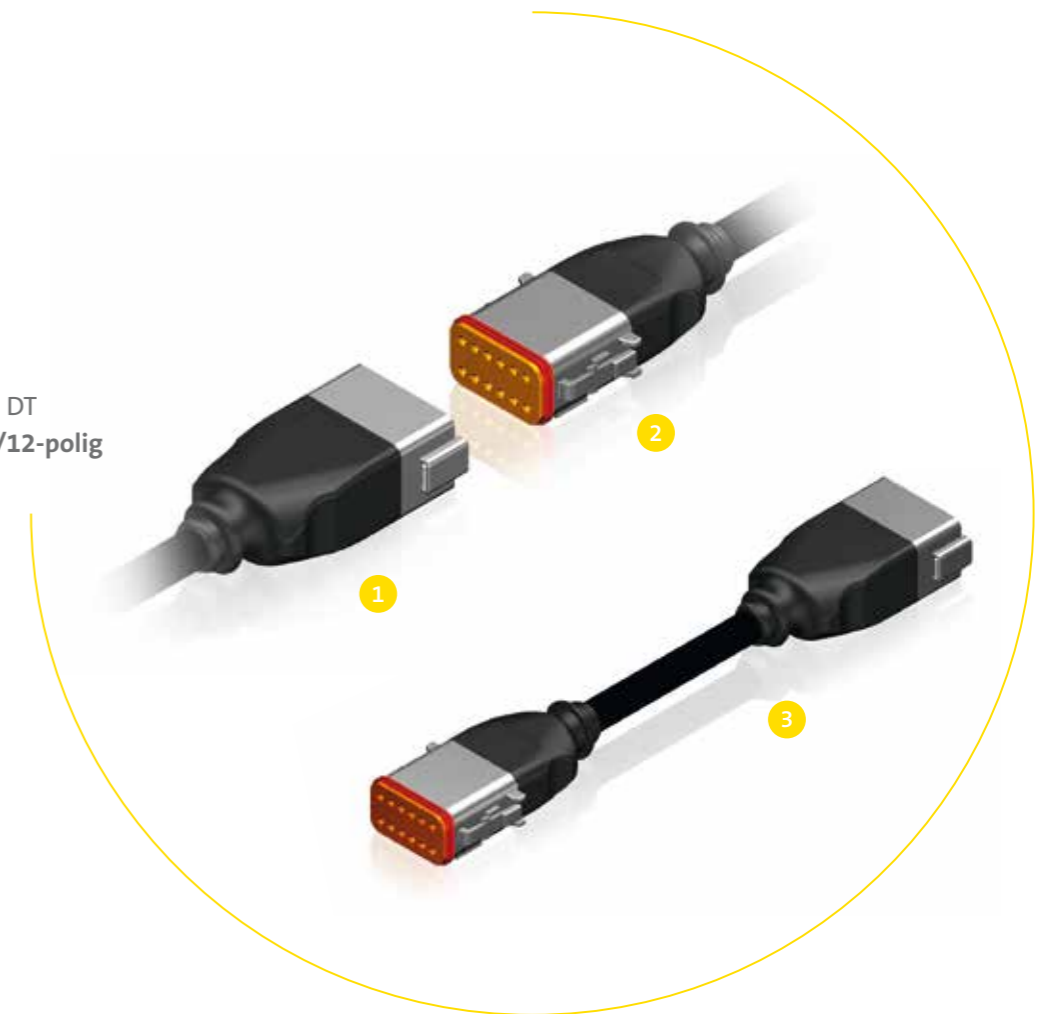

- 1 – Male/Stecker
- 2 – Female/Buchse
- 3 – Connecting cable/Verbindungsleitung

DETAILS

- _ Rated voltage **0 to 230 V**
- _ Operating current **13 A**
- _ Cable **12 x 1,0 mm²**
- _ Connector **Deutsch DT Serie**
- _ Protection class up to **IP 69K**
- _ Housing material **PA**
- _ Locking system **snap-lock**
- _ Temperature range **-20 °C to +80 °C**
- _ LED/surge suppression available on request

- _ Betriebsspannung **0 bis 230 V**
- _ Dauerstrom **13 A**
- _ Leitung **12 x 1,0 mm²**
- _ Steckverbinder **Deutsch DT Serie**
- _ Schutzart bis zu **IP 69K**
- _ Gehäusematerial **PA**
- _ Befestigung **Schnappverriegelung**
- _ Temperaturbereich **-20 °C bis +80 °C**
- _ LED/Schutzbeschaltung auf Anfrage

DEUTSCH DT06-2S

2-POLE/2-POLIG/LED

Deutsch DT 06-2S
2-pole/2-polig /LED

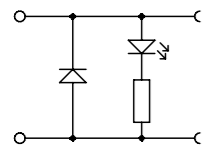

YD: LED+Diode 24 VDC

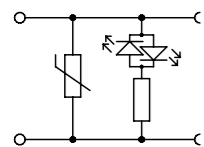

YV: LED+Varistor 24 VAC/DC

DETAILS

_ Rated voltage 10 V to 30 V	_ Betriebsspannung 10 V bis 30 V
_ Operating current 2 A	_ Dauerstrom 2 A
_ Max. load 60 W/60 VA	_ Max. Schaltleistung 60 W/60 VA
_ Cable 2 x 0,75 mm²	_ Leitung 2 x 0,75 mm²
_ Operating indicator LED yellow	_ Betriebsanzeige LED gelb
_ Connector Deutsch DT 06-2S	_ Steckverbinder Deutsch DT 06-2S
_ Protection class up to IP 69K	_ Schutzart bis zu IP 69K
_ Housing material PA	_ Gehäusematerial PA
_ Locking system snap-lock	_ Befestigung Schnappverriegelung
_ Temperature range -20 °C to +80 °C	_ Temperaturbereich -20 °C bis +80 °C
_ LED/surge suppression available on request	_ LED/Schutzbeschaltung auf Anfrage

DEUTSCH DT06-2S/DT04-2P

Y-SPLITTER/Y-VERTEILER

Deutsch DT06-2S/DT04-2P
Y-Splitter/Y-Verteiler

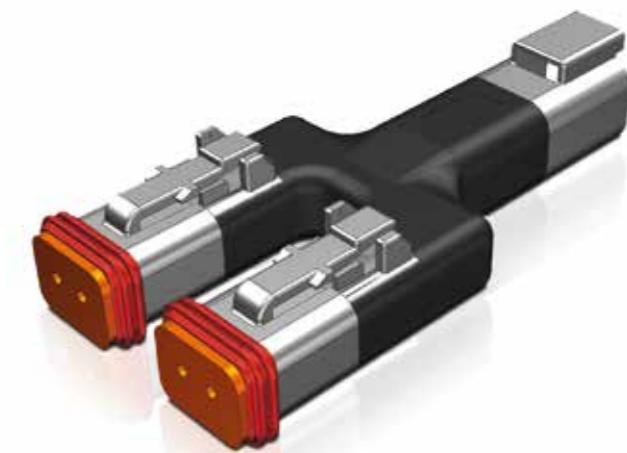

DETAILS

_ Rated voltage 10 to 30 V	_ Betriebsspannung 10 bis 30 V
_ Operating current 13 A	_ Dauerstrom 13 A
_ Connector Deutsch DT Serie	_ Steckverbinder Deutsch DT Serie
_ Protection class up to IP 69K	_ Schutzart bis zu IP 69K
_ Housing material PA	_ Gehäusematerial PA
_ Locking system snap-lock	_ Befestigung Schnappverriegelung
_ Temperature range -20 °C to +80 °C	_ Temperaturbereich -20 °C bis +80 °C
_ LED/surge suppression available on request	_ LED/Schutzbeschaltung auf Anfrage
_ Various versions/poles upon request	_ Weitere Versionen/Polzahlen auf Anfrage

ORDER CODE/BESTELNUMMERN

DEUTSCH DT

2-POLE/2-POLIG



Type/Ausführung	2 m	5 m	10 m
	Part No./ Artikel-Nr.	Part No./ Artikel-Nr.	Part No./ Artikel-Nr.
1 – Male/Stecker DT04-2P	922046	922047	922048
2 – Female/Buchse DT06-2S	922037	922038	922039
3 – Connecting cable/Verbindungsleitung	922107	922108	922109

3-POLE/3-POLIG



Type/Ausführung	2 m	5 m	10 m
	Part No./ Artikel-Nr.	Part No./ Artikel-Nr.	Part No./ Artikel-Nr.
1 – Male/Stecker DT04-3P	922165	922067	922068
2 – Female/Buchse DT04-3S	922166	922063	922064
3 – Connecting cable/Verbindungsleitung	922144	922145	922146

4-POLE/4-POLIG



Type/Ausführung	2 m	5 m	10 m
	Part No./ Artikel-Nr.	Part No./ Artikel-Nr.	Part No./ Artikel-Nr.
1 – Male/Stecker DT04-4P	922049	922050	922051
2 – Female/Buchse DT06-4S	922040	922041	922042
3 – Connecting cable/Verbindungsleitung	922147	922148	922149

6-POLE/6-POLIG



Type/Ausführung	2 m	5 m	10 m
	Part No./ Artikel-Nr.	Part No./ Artikel-Nr.	Part No./ Artikel-Nr.
1 – Male/Stecker DT04-6P	922052	922053	922054
2 – Female/Buchse DT06-6S	922043	922044	922045
3 – Connecting cable/Verbindungsleitung	922150	922151	922152

ORDER CODE/BESTELNUMMERN

DEUTSCH DT

8-POLE/8-POLIG



Type/Ausführung	2 m	5 m	10 m
	Part No./ Artikel-Nr.	Part No./ Artikel-Nr.	Part No./ Artikel-Nr.
1 – Male/Stecker DT04-8P	922121	922122	922123
2 – Female/Buchse DT06-8S	922118	922119	922120
3 – Connecting cable/Verbindungsleitung	922153	922154	922155

12-POLE/12-POLIG



Type/Ausführung	2 m	5 m	10 m
	Part No./ Artikel-Nr.	Part No./ Artikel-Nr.	Part No./ Artikel-Nr.
1 – Male/Stecker DT04-12P	922116	922167	922168
2 – Female/Buchse DT06-12S	922169	922170	922171
3 – Connecting cable/Verbindungsleitung	922156	922157	922158

2-POLE/2-POLIG/LED



Type/Ausführung	2 m	5 m	10 m	Optional
	Part No./ Artikel-Nr.	Part No./ Artikel-Nr.	Part No./ Artikel-Nr.	
Connecting cable/Verbindungsleitung	922110	922111	922112	LED + Diode
Connecting cable/Verbindungsleitung	922113	922114	922115	LED + Varistor
Male/Stecker DT04-2P	922101	922102	922103	LED + Diode
Male/Stecker DT04-2P	922104	922105	922106	LED + Varistor
Female/Buchse DT06-2S	922302	922305	922310	LED + Diode
Female/Buchse DT06-2S	922202	922205	922210	LED + Varistor
Female/Buchse/180° DT06-2S	922159	922160	922161	LED + Diode
Female/Buchse/180° DT06-2S	922162	922163	922164	LED + Varistor
Female/Buchse/180° DT06-2S	922172	922173	922174	

DEUTSCH DT06-2S/DT04-2P



	Part No./Artikel-Nr.
Y-Splitter/ Y-Verteiler	992334

TYCO JUNIOR POWER TIMER

LED AND SUPPRESSION/ LED-DIODE/VARISTOR

Tyco Junior Power Timer
Power and control cable/
Mantelleitung

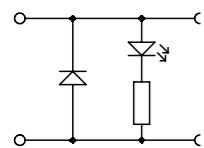

YD: LED+Diode 24 VDC

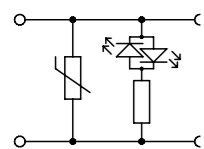

YV: LED+Varistor 24 VAC/DC

DETAILS

_ Rated voltage **10 V to 30 V**

_ Operating current **2 A**

_ Max. load **60 W/60 VA**

_ Cable **2 x 0,75 mm²**

_ Operating indicator **LED yellow**

_ Connector **Junior Power Timer 2-pol.**

_ Protection class **IPX 4K**

_ Housing material **PA**

_ Locking system **locking spring**

_ Temperature range **-20 °C to +80 °C**

_ Betriebsspannung **10V bis 30 V**

_ Dauerstrom **2 A**

_ Max. Schaltleistung **60 W/60 VA**

_ Leitung **2 x 0,75 mm²**

_ Betriebsanzeige **LED gelb**

_ Steckverbinder **Junior Power Timer 2-pol.**

_ Schutzart **IPX 4K**

_ Gehäusematerial **PA**

_ Befestigung **Verriegelungsfeder**

_ Temperaturbereich **-20 °C bis +80 °C**

TYCO JUNIOR POWER TIMER

LED AND SUPPRESSION/ LED-DIODE/VARISTOR

Tyco Junior Power Timer
Single conductors/Litze

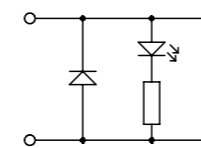

YD: LED+Diode 24 VDC

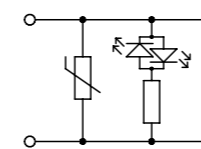

YV: LED+Varistor 24 VAC/DC

DETAILS

_ Rated voltage **10 V to 30 V**

_ Operating current **2 A**

_ Max. load **60 W/60 VA**

_ Cable **FLRY 2x 1,0mm² rd/bk**

_ Operating indicator **LED yellow**

_ Connector **Junior Power Timer 2-pol.**

_ Protection class **IPX 4K**

_ Housing material **PA**

_ Locking system **locking spring**

_ Temperature range **-20 °C to +80 °C**

_ Betriebsspannung **10 V bis 30 V**

_ Dauerstrom **2 A**

_ Max. Schaltleistung **60 W/60 VA**

_ Leitung **FLRY 2x 1,0mm² rd/bk**

_ Betriebsanzeige **LED gelb**

_ Steckverbinder **Junior Power Timer 2-pol.**

_ Schutzart **IPX 4K**

_ Gehäusematerial **PA**

_ Befestigung **Verriegelungsfeder**

_ Temperaturbereich **-20 °C bis +80 °C**

TYCO JUNIOR POWER TIMER

16-POLE/16-POLIG

Tyco Junior Power Timer
16-pole/16-polig

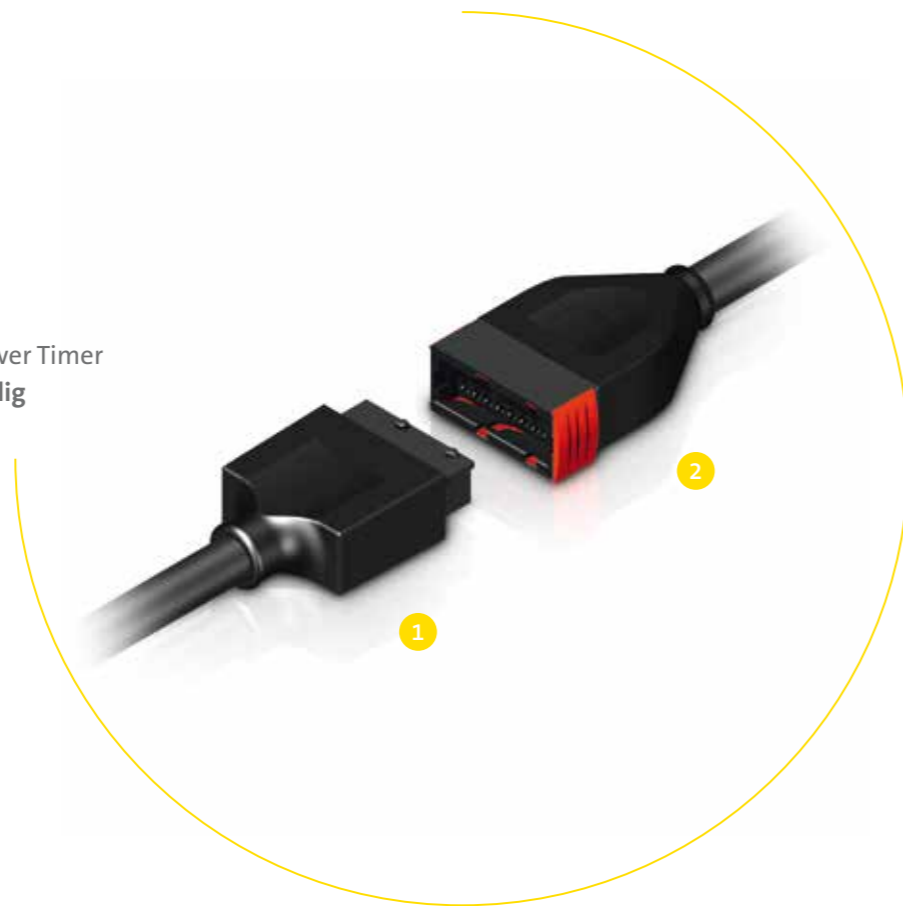

1 – Male/Stecker
2 – Female/Buchse

DETAILS

_ Rated voltage 0 to 16 V	_ Betriebsspannung 0 bis 16 V
_ Operating current 10 A	_ Dauerstrom 10 A
_ Cable 16 x 1,5 mm²	_ Leitung 16 x 1,5 mm²
_ Connector Junior Power Timer 16-poles	_ Steckverbinder Junior Power Timer 16-polig
_ Protection class IPX 4K	_ Schutzart IPX 4K
_ Housing material PA	_ Gehäusematerial PA
_ Locking system sliding lock	_ Befestigung Schiebeverschluss
_ Temperature range -20 °C to +80 °C	_ Temperaturbereich -20 °C bis +80 °C
_ Various versions upon request	_ Weitere Größen auf Anfrage

ORDER CODE/BESTELLNUMMERN

TYCO JUNIOR POWER TIMER

POWER AND CONTROL CABLE/MANTELEITUNG



Circuit/Beschaltung	2 m	5 m	10 m
	Part No./Artikel Nr.	Part No./Artikel Nr.	Part No./Artikel Nr.
LED + Diode	924302	924305	924310
LED + Varistor	924202	924205	924210

SINGLE CONDUCTORS/LITZE



Circuit/Beschaltung	2 m	5 m	10 m
	Part No./Artikel Nr.	Part No./Artikel Nr.	Part No./Artikel Nr.
LED + Diode	914302	914305	914310
LED + Varistor	914202	914205	914210

16-POLE/16-POLIG



Type/Ausführung	2 m	5 m	10 m
	Part No./Artikel Nr.	Part No./Artikel Nr.	Part No./Artikel Nr.
1 – Male/Stecker	909007	909008	909009
2 – Female/Buchse	909010	909011	909012

DELPHI METRI-PACK

6-POLE/6-POLIG

Delphi Metri-Pack
6-pole/6-polig



Delphi Metri-Pack
6-pole/6-polig/90°



DETAILS

_ Rated voltage **0 to 24 VDC**

_ Operating current **4 A**

_ Cable **6 x 0,34 mm²**

_ Connector **Delphi Metri-Pack 150.2 Serie**

_ Protection class **IP67**

_ Housing material **PA**

_ Locking system **snap-lock**

_ Temperature range **-20 °C to +80 °C**

_ Betriebsspannung **0 bis 24 VDC**

_ Dauerstrom **4 A**

_ Leitung **6 x 0,34 mm²**

_ Steckverbinder **Delphi Metri-Pack 150.2 Serie**

_ Schutzart **IP67**

_ Gehäusematerial **PA**

_ Befestigung **Schnappverriegelung**

_ Temperaturbereich **-20 °C bis +80 °C**

DELPHI METRI-PACK

10-POLE/10-POLIG

Delphi Metri-Pack
10-pole/10-polig



DETAILS

_ Rated voltage **0 to 24 VDC**

_ Operating current **10 A**

_ Cable **10 x 1,0 mm²**

_ Connector **Delphi Metri-Pack 150 Serie**

_ Protection class **IP67**

_ Housing material **PA**

_ Locking system **snap-lock**

_ Temperature range **-20 °C to +80 °C**

_ Betriebsspannung **0 bis 24 VDC**

_ Dauerstrom **10 A**

_ Leitung **10 x 1,0 mm²**

_ Steckverbinder **Delphi Metri-Pack 150 Serie**

_ Schutzart **IP67**

_ Gehäusematerial **PA**

_ Befestigung **Schnappverriegelung**

_ Temperaturbereich **-20 °C bis +80 °C**

ST3 CONNECTOR – DIN 9680

3-POLE/3-POLIG

ST3 Connector – DIN 9680
3-pole/3-polig



DETAILS

_ Rated voltage 6 to 24 VDC	_ Betriebsspannung 6 bis 24 VDC
_ Operating current 25 A	_ Dauerstrom 25 A
_ Cable 2 x 2,5 mm²/PIN 3 not used	_ Leitung 2 x 2,5 mm²/PIN 3 nicht belegt
_ Connector ST3, DIN 9680	_ Steckverbinder ST3, DIN 9680
_ Protection class IP54	_ Schutzart IP54
_ Housing material PA	_ Gehäusematerial PA
_ Locking system socket retaining claw	_ Befestigung Haltekralle Steckdose
_ Temperature range -25 °C to +75 °C	_ Temperaturbereich -25 °C bis +75 °C
_ Female version available	_ Buchse verfügbar

CUSTOMIZED SPLITTER UPON REQUEST

2-WAY/3-WAY PRE-WIRED

VERTEILER AUF KUNDENWUNSCH

2-FACH/3-FACH MIT ANSCHLUSSLEITUNG

2-way/2-fach



3-way/3-fach



8-way/8-fach



OTHER CONFIGURATIONS UPON REQUEST/ANDERE KONFIGURATIONEN AUF ANFRAGE

Type/Ausführung	Request No./Anfrage Nr.
2-way/2-fach	99-002-2
3-way/3-fach	99-002-3
8-way/8-fach	99-002-8

ORDER CODE/BESTELLNUMMERN

DELPHI METRI-PACK

6-POLE/6-POLIG



Circuit/Beschaltung	2 m	5 m	10 m
	Part No./Artikel Nr.	Part No./Artikel Nr.	Part No./Artikel Nr.
12162261/Female/Buchse	909001	909002	909003
12162261/Female/Buchse	909016	909017	909018

10-POLE/10-POLIG



Circuit/Beschaltung	2 m	5 m	10 m
	Part No./Artikel Nr.	Part No./Artikel Nr.	Part No./Artikel Nr.
12065425/Female/Buchse	909004	909005	909006

ORDER CODE/BESTELLNUMMERN

ST3 CONNECTOR – DIN9680

2-POLE/2-POLIG



Type/Ausführung	2 m	5 m	10 m
	Part No./ Artikel-Nr.	Part No./ Artikel-Nr.	Part No./ Artikel-Nr.
Male/Stecker	909013	909014	909015

OTHER CABLES UPON REQUEST/ANDERE LEITUNGEN AUF ANFRAGE

PERFECT
SOLUTIONS BY
GERMAN
ENGINEERING

www.peters-indu.de

NOTES

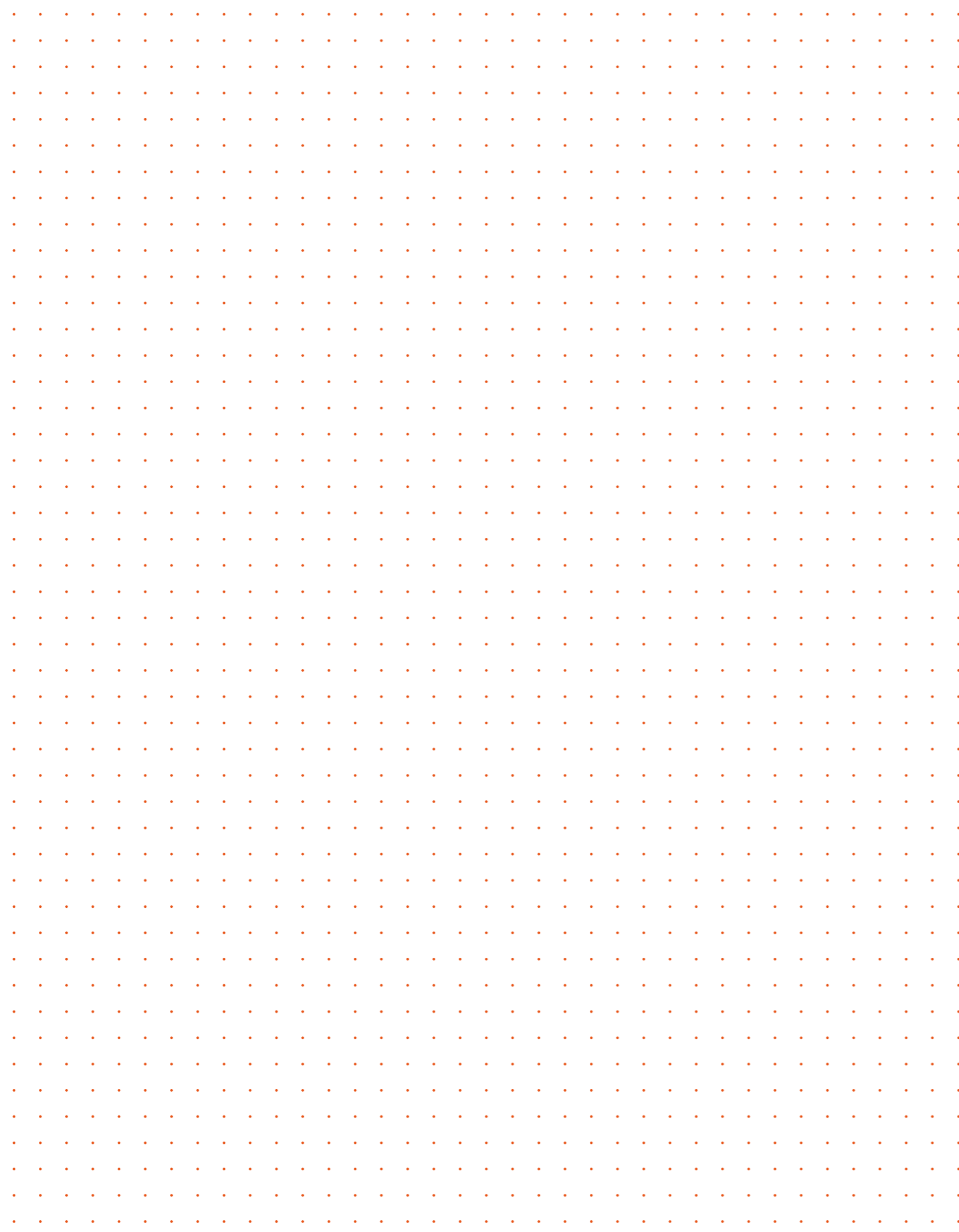





PRODUCT PORTFOLIO/ PRODUKTPORTFOLIO EXTRACT/AUSZUG





				
Connector DIN-EN Steckverbinder DIN-EN	Valve Timer Ventil Timer	Pressure Switch Electronic Druckschalter Elektronik	Pressure Switch Hydraulic Druckschalter Hydraulik	Pressure Switch Pneumatic Druckschalter Pneumatik



			
Safety Gas Valve 1/2" up to 1" EN161 Sicherheitsgasventil 1/2" bis 1" EN 161	Safety Gas Valve 1 1/2" up to DN 300 EN161 Sicherheitsgasventil 1 1/2" bis DN 300 EN 161	Gas Filter Gasfilter	PWM Energy Saving Module PWM Energiesparmodul



				
Connector M12 Steckverbinder M12	Connector M12 Steckverbinder M12	M12 Actuator-/ Sensor-Box M12 Aktor-/ Sensor-Box	M8 Actuator-/ Sensor-Box M8 Aktor-/ Sensor-Box	Connector M12 Field attachable Steckverbinder M12 Konfektionierbar



Peters Indu-Produkt GmbH
Mercatorstrasse 41
46485 Wesel
Germany

T +49 (0)281.9546 0
F +49 (0)281.9546 30



info@peters-indu.de
www.peters-indu.de